



For Years 1-3



Alphabet Activities

Book 2 Jigsaws and Word Matching

Written by Kerry Heathcote & Kathryn Bryce. © Ready-Ed Publications - 2006.
Published by Ready-Ed Publications (2006) P.O. Box 276 Greenwood Perth W.A. 6024
Email: info@readyed.com.au Website: www.readyed.com.au

COPYRIGHT NOTICE

Permission is granted for the purchaser to photocopy sufficient copies for non-commercial educational purposes. However, this permission is not transferable and applies only to the purchasing individual or institution.

ISBN 1 86397 658 2

Rationale

Sound Jigsaws and Word Matching is the second in a four part series called *Alphabet Activities*. It is for use in an early literacy program. This second book provides teachers with a practical series of activity-based worksheets which expand the body of work set out in *Initial Sounds*. The worksheets provide children with the opportunity to identify sounds through a variety of exercises such as cut-and-paste, read and draw, true and false, matching words to pictures and labelling. These activities foster, encourage and reinforce sound recognition, letter formation, letter-sound relationships and fine motor skills. They have been designed to motivate students to develop and learn.

About the Authors

Kerry Heathcote has 36 years teaching experience in Early Childhood in Queensland, New South Wales and Victoria.

Kathryn Bryce is a graphic designer with a Bachelor of Arts (Hons.) degree majoring in Communications. She has worked as a tutor with both children and adults with learning disabilities.

Curriculum Links - Links to Achievement Objectives

English - Level 1

Reading

Personal Reading - Students will begin to use semantic, syntactic, visual, and grapho-phonetic cues to gain meaning.

Close Reading - Students will respond to language and meanings in texts.

Reading Processes

Exploring Language - Students will explore choices made by writers, and identify and use the common conventions of writing and organisation of text which affect understanding.

Mixed Letter Z Exercises

Name: _____

Read and Draw

This is my favourite animal at the zoo.

Which word matches the picture?
pip zip tip sip

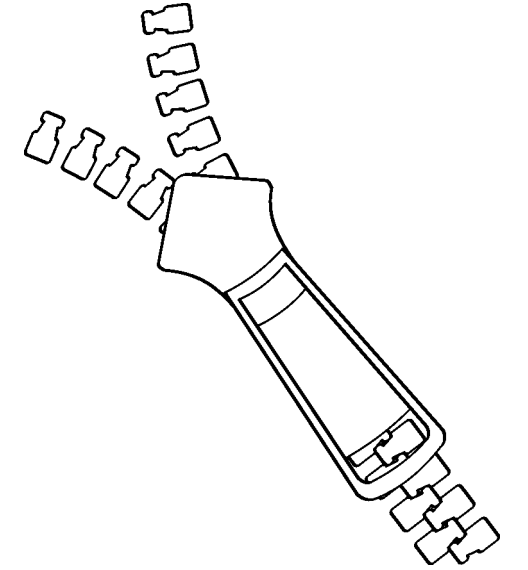

Which words start with **z**?

sat zoo as sip

soup sit sock zip

zap sign six say

True or False?

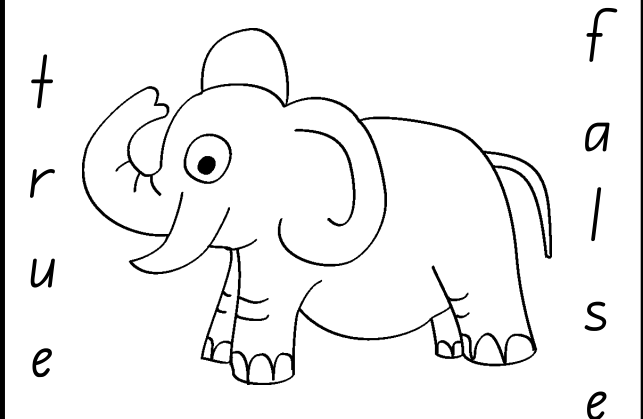

This is a zebra.

Letter Z Jigsaw

Name: _____

Colour the words and the pictures that begin with **Z**.

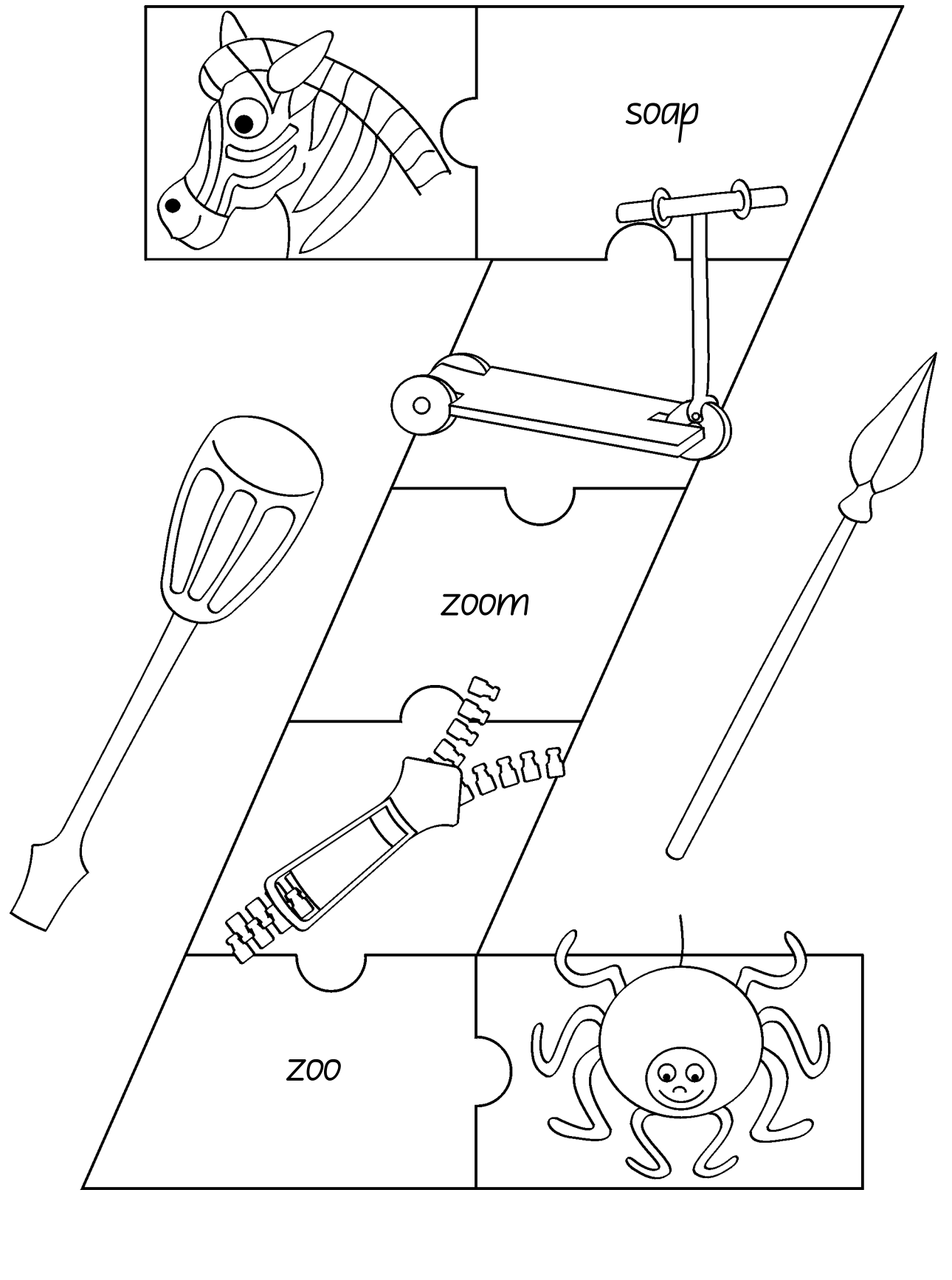

Contents

Letter A Jigsaw page 4
Mixed Letter A Exercises page 5
Letter B Jigsaw page 6
Mixed Letter B Exercises page 7
Letter C Jigsaw page 8
Mixed Letter C Exercises page 9
Letter D Jigsaw page 10
Mixed Letter D Exercises page 11
Letter E Jigsaw page 12
Mixed Letter E Exercises page 13
Letter F Jigsaw page 14
Mixed Letter F Exercises page 15
Letter G Jigsaw page 16
Mixed Letter G Exercises page 17
Letter H Jigsaw page 18
Mixed Letter H Exercises page 19
Letter I Jigsaw page 20
Mixed Letter I Exercises page 21
Letter J Jigsaw page 22
Mixed Letter J Exercises page 23
Letter K Jigsaw page 24
Mixed Letter K Exercises page 25
Letter L Jigsaw page 26
Mixed Letter L Exercises page 27
Letter M Jigsaw page 28
Mixed Letter M Exercises page 29
Letter N Jigsaw page 30
Mixed Letter N Exercises page 31
Letter O Jigsaw page 32
Mixed Letter O Exercises page 33
Letter P Jigsaw page 34
Mixed Letter P Exercises page 35
Letter Q Jigsaw page 36
Mixed Letter Q Exercises page 37
Letter R Jigsaw page 38
Mixed Letter R Exercises page 39
Letter S Jigsaw page 40
Mixed Letter S Exercises page 41
Letter T Jigsaw page 42
Mixed Letter T Exercises page 43
Letter U Jigsaw page 44
Mixed Letter U Exercises page 45
Letter V Jigsaw page 46
Mixed Letter V Exercises page 47
Letter W Jigsaw page 48
Mixed Letter W Exercises page 49
Letter X Jigsaw page 50
Mixed Letter X Exercises page 51
Letter Y Jigsaw page 52
Mixed Letter Y Exercises page 53
Letter Z Jigsaw page 54
Mixed Letter Z Exercises page 55

Letter *a* Jigsaw

Name: _____

Colour the words and the pictures that begin with *a*.

Mixed Letter *y* Exercises

Name: _____

Read and Draw

Here is a big yellow square.

Which word matches the picture?

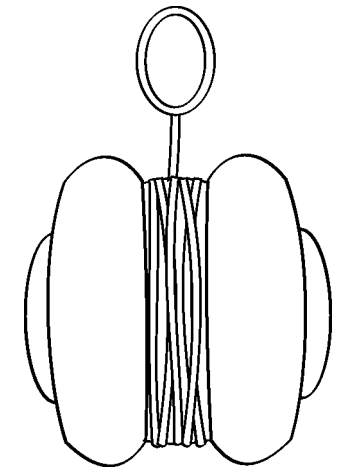

yo-yo

go-go

Which words do not start with *y*?

yes your card yard

year yet yellow ear

sell yard you yell

True or False?

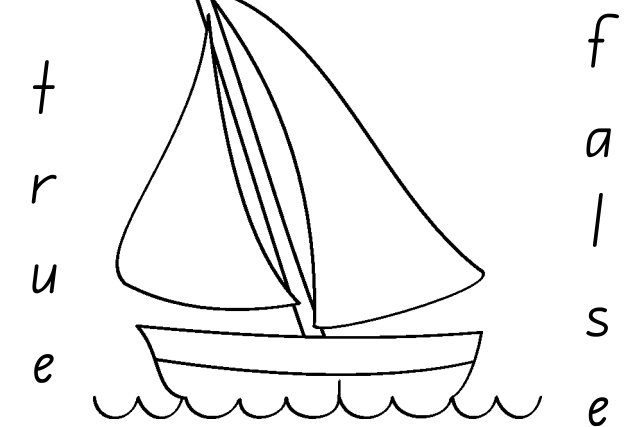

This yacht has two sails.

Letter *y* Jigsaw

Name: _____

Colour the words and the pictures that contain the letter **y**.

key

you

boy

1st

yellow

Mixed Letter *a* Exercises

Name: _____

Which words do not have **a** in them?

wall till tall call

sat bat sit cat

ill all wall tall

Can you find these **a** words?

~~also~~ and ant
ask at axe

o	t	o	s	k	a
a	a	l	s	o	t
a	x	a	n	b	e
n	e	a	n	d	d
t	b	a	l	o	s

Which word matches the picture?

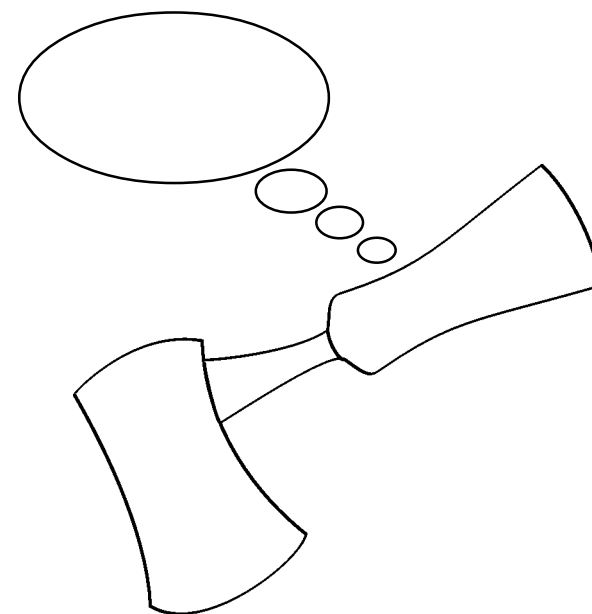

axe ace

True or False?

t		f
r		a
u		i
e		s
		e

This is an apple.

Letter *b* Jigsaw

Name: _____

Colour the words and the pictures that begin with *(b)*.

about

boy

dog

boat

big

duck

Mixed Letter X Exercises

Name: _____

Which pictures have *(x)* in them?

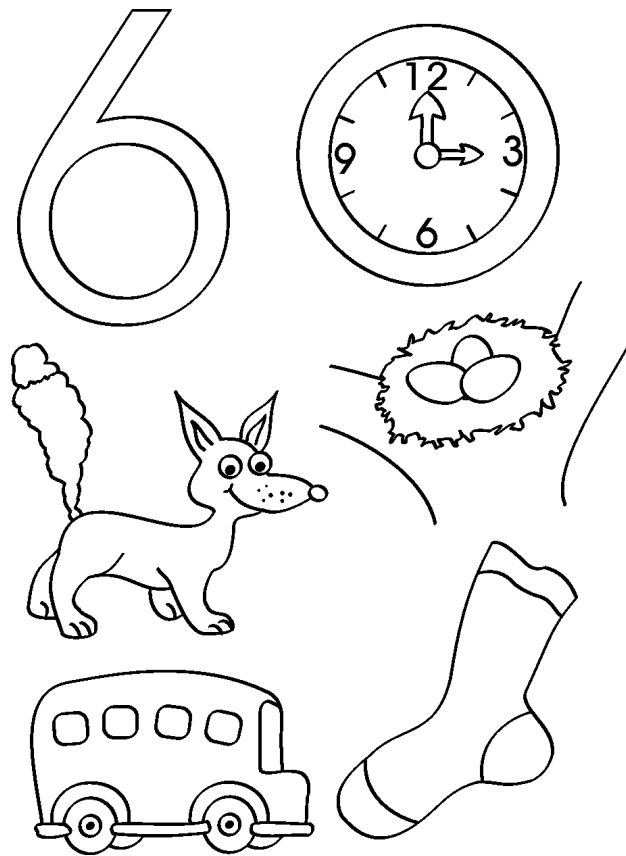

Can you find these words?

~~box~~ fix fox
mix six wax

b	b	o	x	x	l
b	i	x	s	w	a
f	i	x	i	i	m
f	f	o	x	x	i
t	i	w	w	a	x

Which word matches the picture?

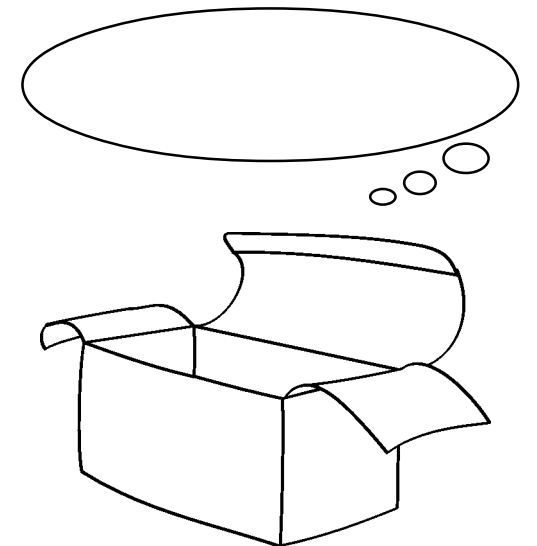

box fox

True or False?

t
r
u
e

f
a
l
s
e

This is an X-ray.

Letter X Jigsaw

Name: _____

Colour the words and the pictures that contain the letter **X**.

Mixed Letter **b** Exercises

Name: _____

Match the words to the picture.

Add **(b)** and draw the picture.

Letter C Jigsaw

Name: _____

Colour the words and the pictures that begin with **C**.

rice

child

ice

kick

Mixed Letter Exercises

Name: _____

True or False?

t r u e

f a l s e

This is a big whale.

Which word matches the picture?

wheel peel

Which words start with **w**?

we wool away wind

went won well bow

sew will way wall

Can you find these **w** words?

~~wag~~ wax web
wet why wig

w	w	e	t	a	w
e	t	w	o	t	a
w	w a g	g	t		
e	p	x	w	h	y
b	w	w	i	g	g

Letter W Jigsaw

Name: _____

Colour the words and the pictures that begin with **W**.

two

away

went

will

snow

w

w

w

Mixed Letter C Exercises

Name: _____

Add **C** and draw the picture.

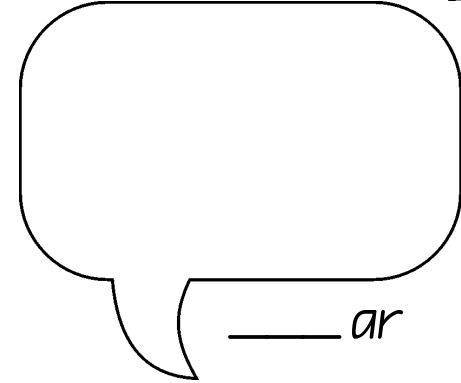
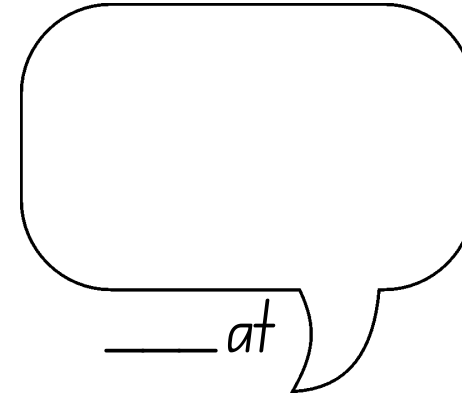

Which word matches the picture?

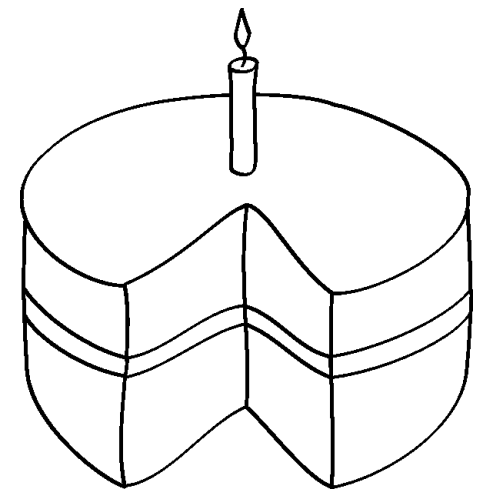

- cake
- cot
- cat
- car

Which words do not start with **C**?

cat cap car ace

come cut duck crab

cool key cow camera

Can you find these **c** words?

- ~~cap~~ car cat
- cot cow cut

b	o	c	u	t	t
c	o	t	c	o	r
o	c	c	a	t	o
w	e	s	r	r	a
c	a	p	k	o	w

Letter *d* Jigsaw

Name: _____

Colour the words and the pictures that begin with **(d)**.

The jigsaw puzzle consists of several pieces:

- A bucket (top left)
- A book (top right)
- The word "do" (middle left)
- A duck (middle left)
- A diamond shape (middle right)
- The word "add" (middle right)
- A dinosaur (bottom right)
- The word "day" (bottom left)
- A bow (bottom left)
- The word "ball" (bottom right)

Mixed Letter *v* Exercises

Name: _____

Which pictures start with **(v)**?

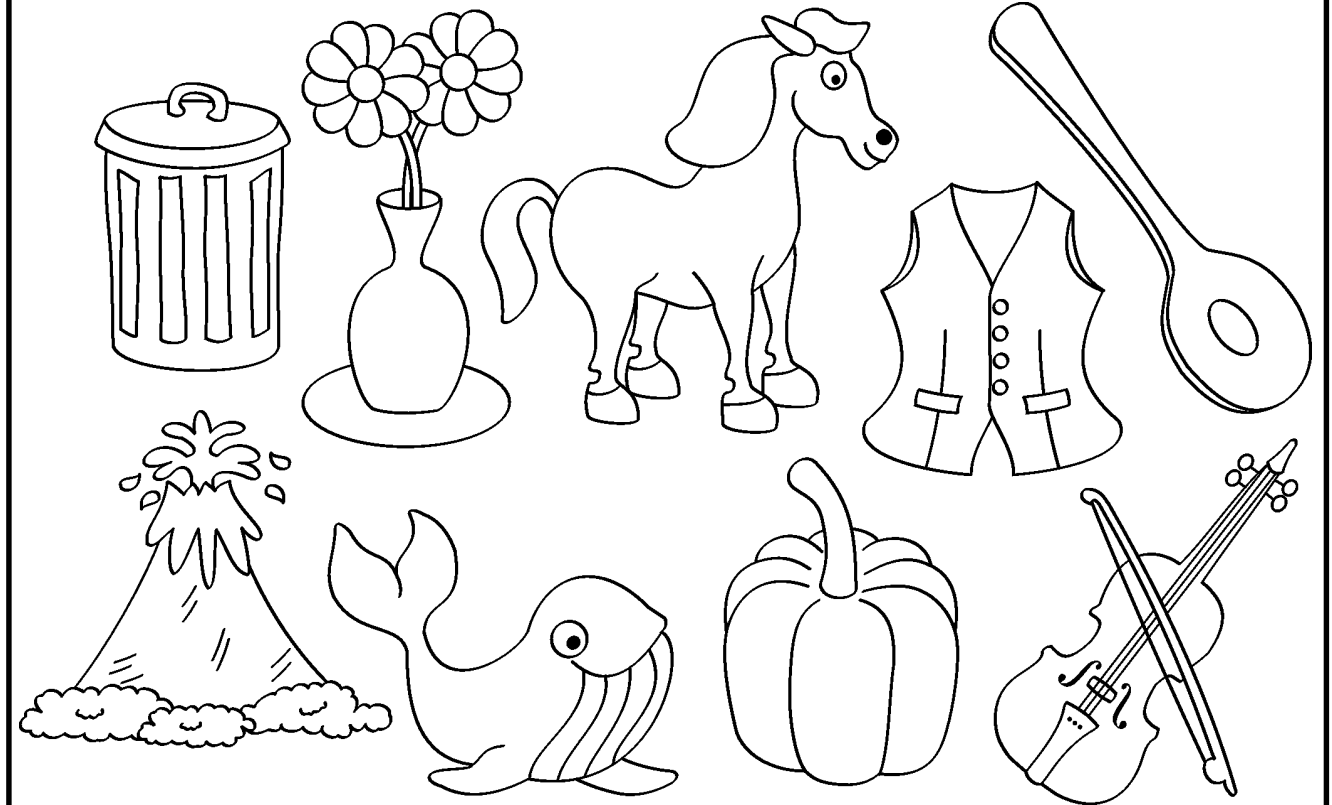

Which word matches the picture?

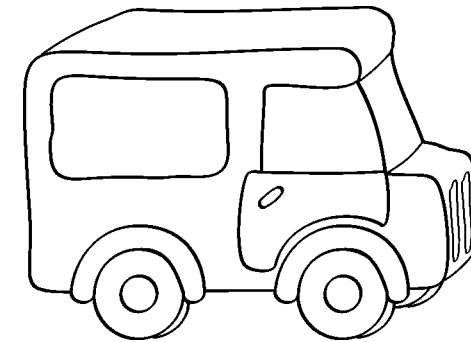
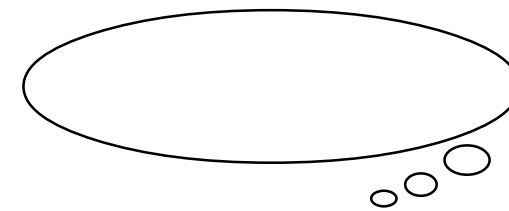

van

ban

True or False?

t
r
u
e

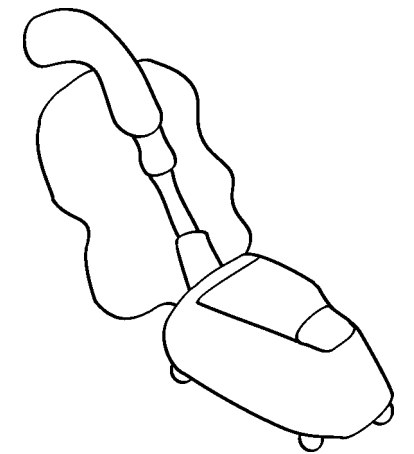

f
a
l
s
e

This is a van.

Letter *v* Jigsaw

Name: _____

Colour the words and the pictures that begin with *v*.

Mixed Letter *d* Exercises

Name: _____

Add *d* and draw the picture.

_____og

_____oll

_____ad

Which word matches the picture?



dog dig

True or False?

t
r
u
e

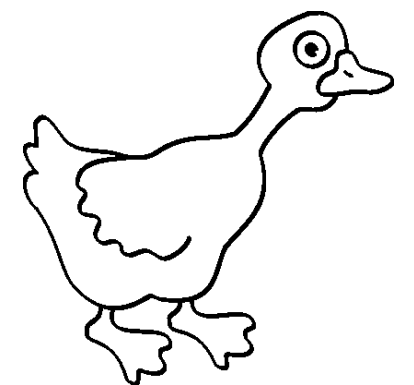

f
a
l
s
e

This is a little duck.

Letter e Jigsaw

Name: _____

Colour the words and the pictures that begin with **e**.

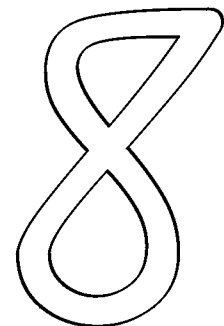
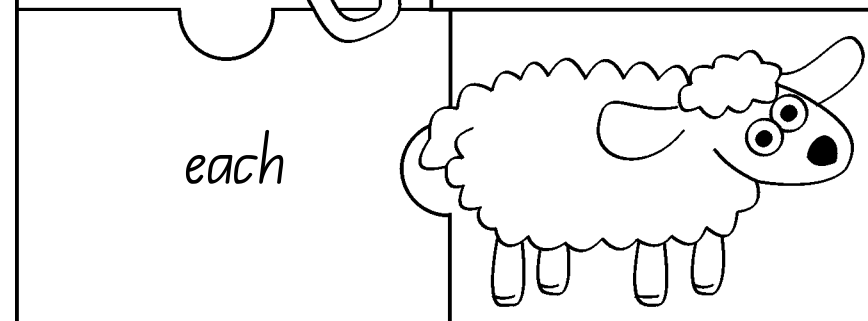
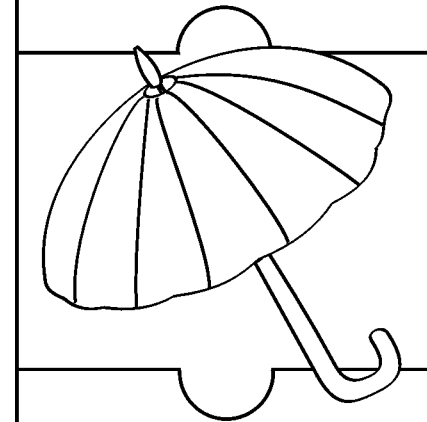
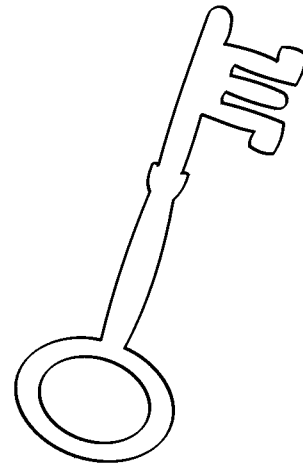
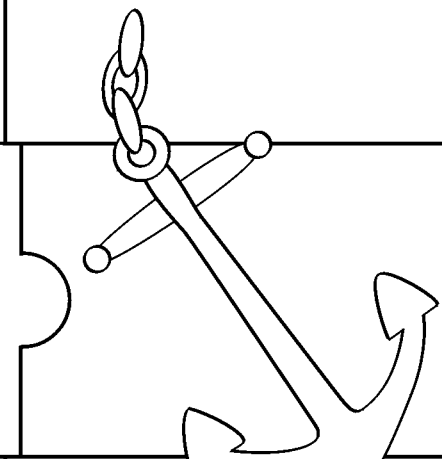
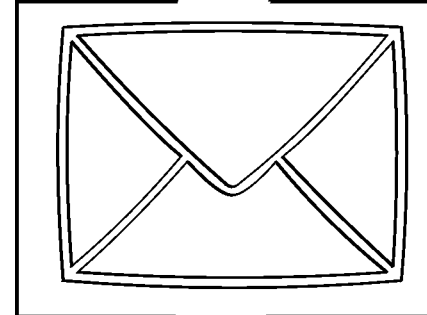
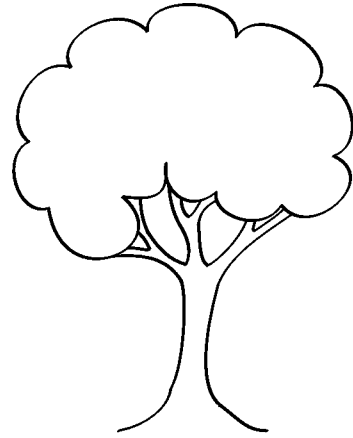
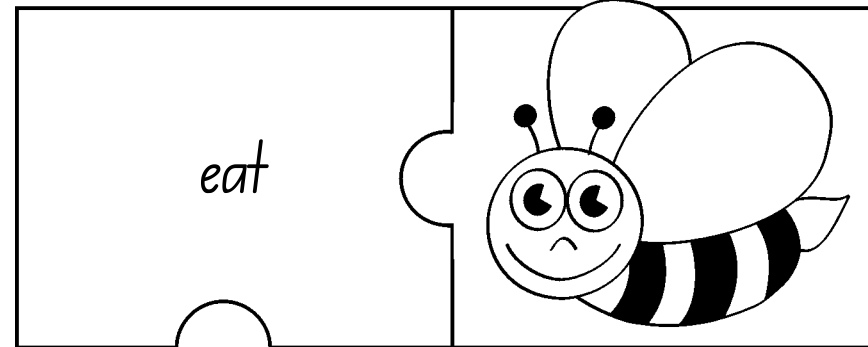

Mixed Letter U Exercises

Name: _____

Add **u** and draw the picture.

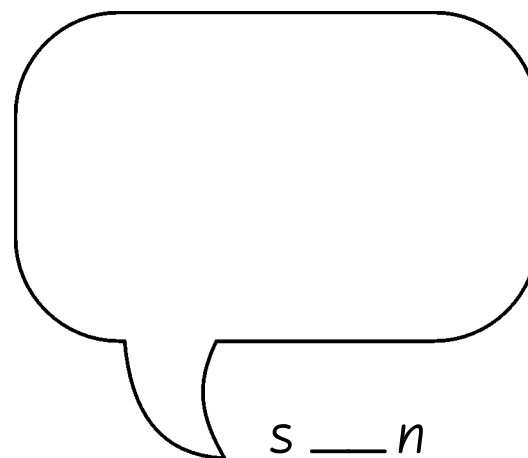
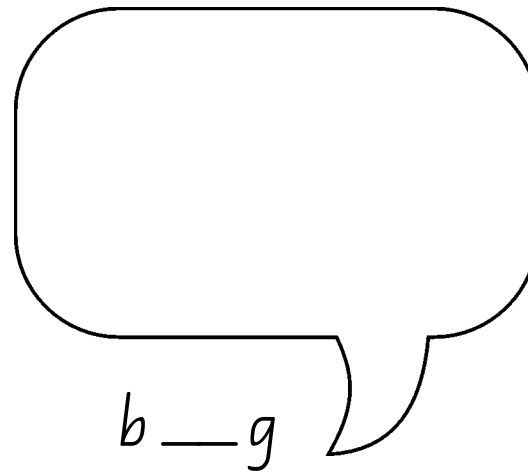
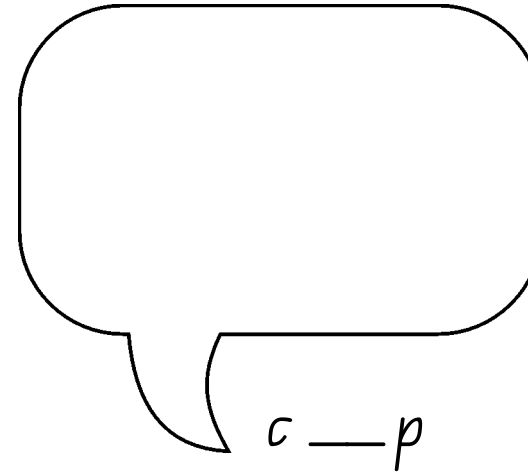

Which words start with **u**?

pup tub up cub

so is us as

use quill pill bub

True or False?



This is an umbrella.

Letter U Jigsaw

Name: _____

Colour the words and the pictures that begin with **u**.

under

but

but

at

us

Illustrations include: a unicorn, a person in a spacesuit, a box of ice cream, an umbrella, and an octopus.

Mixed Letter e Exercises

Name: _____

Circle the picture that starts with **e**.

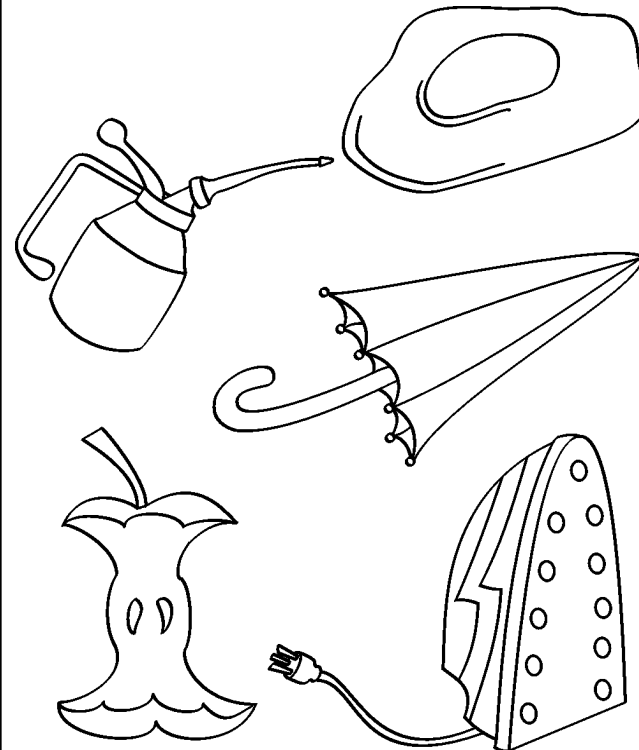

Read and Draw

Here is a pink elephant.

Can you find these words?

- ~~ear~~ eel egg
- elf end emu

e	g	g	e	e	i
l	e	g	e	n	d
f	l	e	e	l	e
e	m	u	a	n	o
e	n	u	r	e	r

Which word matches the picture?

- ear emu eel owl

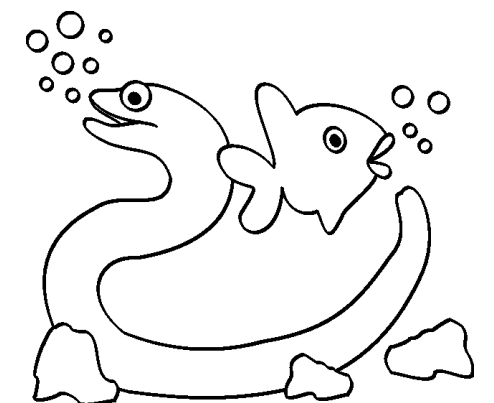

Letter *f* Jigsaw

Name: _____

Colour the words and the pictures that begin with **f**.

fan

after

if

Mixed Letter *f* Exercises

Name: _____

Can you find these **f** words?
~~tap~~ the tip
 toe too top

t	h	o	f	a	p
t	t	o	o	o	t
o	i	r	p	e	t
e	p	r	t	h	e
t	u	p	t	e	o

Add **f** and draw the picture.

_____ree

_____ent

Match the words to the pictures:

2

tap two ten

Which word matches the picture?

tree train

Letter **f** Jigsaw

Name: _____

Colour the words and the pictures that begin with **f**.

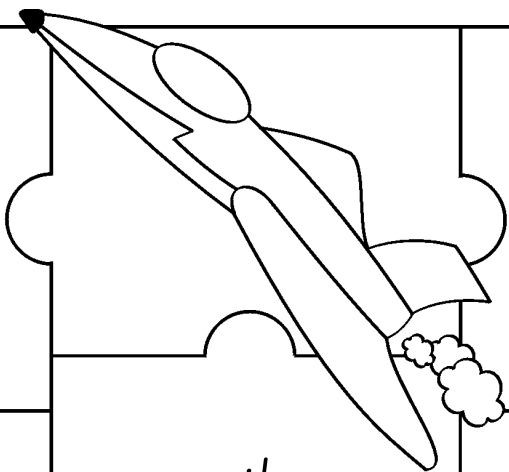
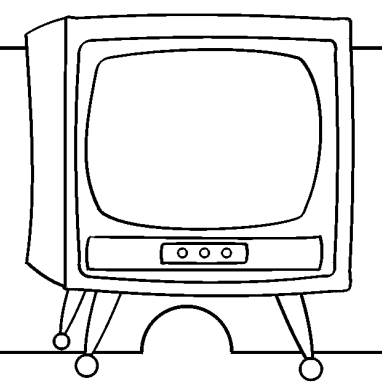
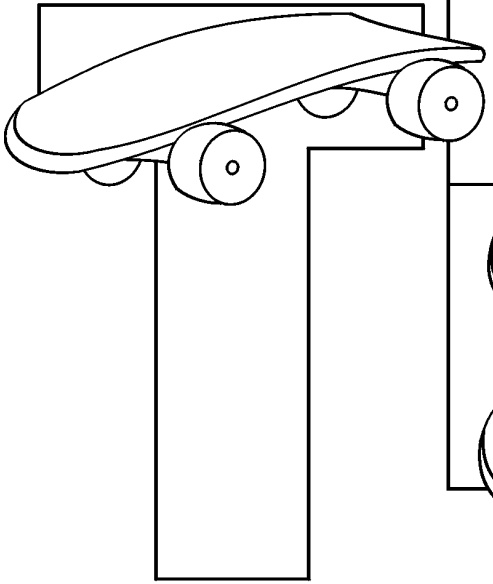
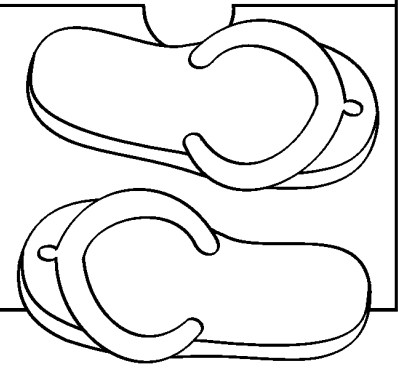
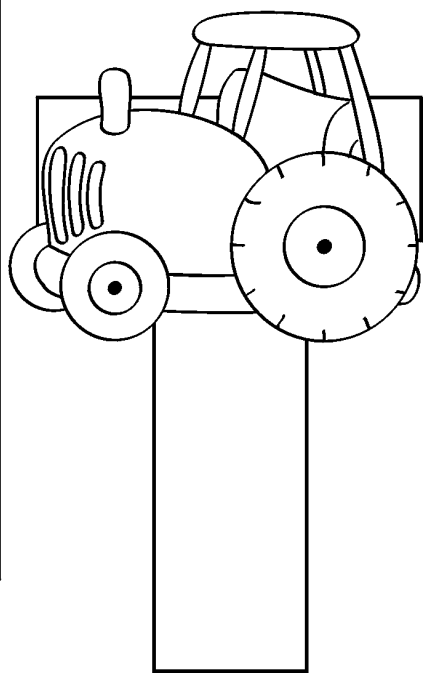
toy		too
	it	
		
	at	
		

Mixed Letter **f** Exercises

Name: _____

Which word matches the picture?

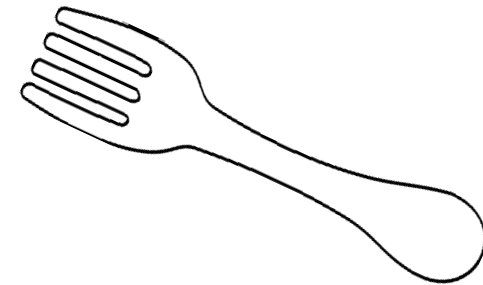

fish foot fork frog

Which words do not start with **f**?

feet five puff find

fat if four feel

fit foal of for

True or False?

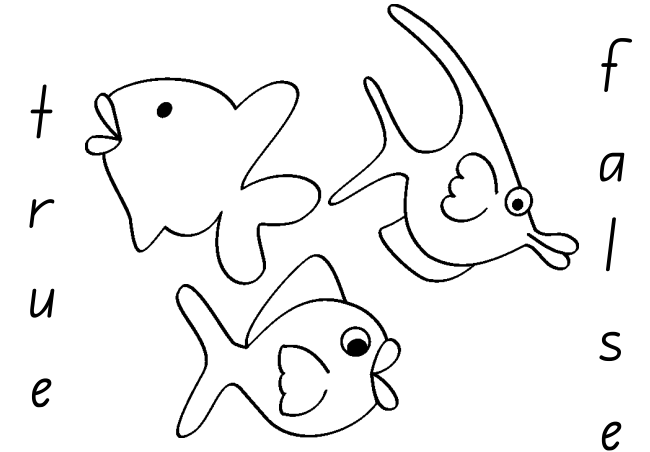

True

False

Here are three little fish.

Read and Draw

I can draw the number five.

Letter *g* Jigsaw

Name: _____

Colour the words and the pictures that begin with *g*.

The jigsaw puzzle consists of several pieces:

- Top left: A cartoon ghost with arms raised. Word: *gill*
- Middle left: A piece with the word *age*.
- Bottom left: A piece with a picture of a log. Word: *goat*
- Bottom right: A piece with a picture of a bear. Word: *mug*
- Bottom right: A piece with a picture of a girl. Word: *girl*

Mixed Letter *S* Exercises

Name: _____

Can you find these *s* words?

- ~~sad~~ say see
- sip six so

s	i	x	x	s	a
o	b	s	s	i	p
s	a	s	a	d	o
e	e	a	y	o	s
y	e	s	s	e	e

True or False?

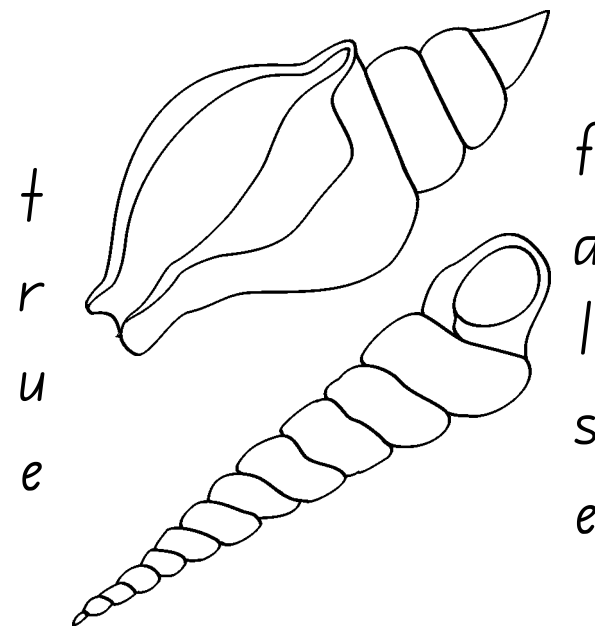

Here are two sharks.

Match the words to the pictures:

sun saw six

Which word matches the picture?

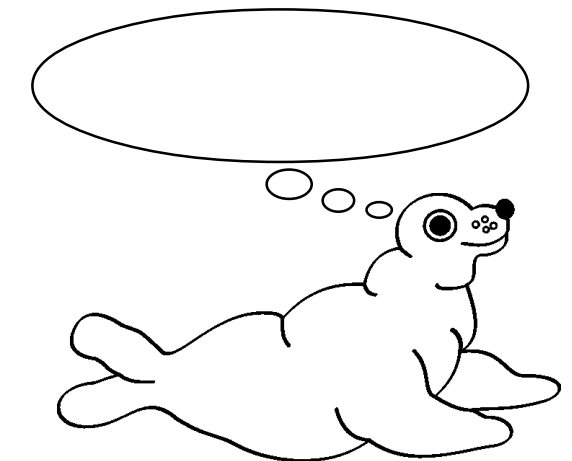

seal meal

Letter S Jigsaw

Name: _____

Colour the words and the pictures that begin with **(s)**.

sat

sip

is

as

Mixed Letter Exercises

Name: _____

True or False?

t
r
u
e

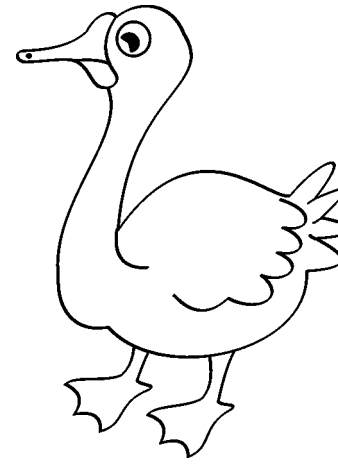

f
a
l
s
e

This is a goose.

Add **(g)** and draw the picture.

—irl

—ate

Which word matches the picture?

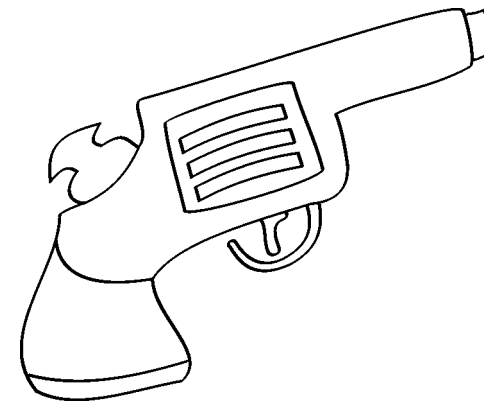

bun fun run gun

Which words do not start with **(g)**?

egg gun gill get

got girl go ago

good age game gone

Letter *h* Jigsaw

Name: _____

Colour the words and the pictures that begin with **h**.

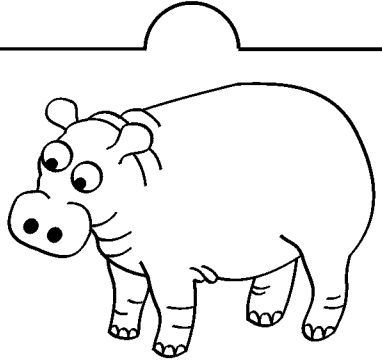
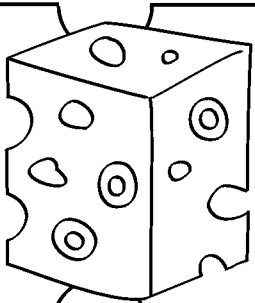
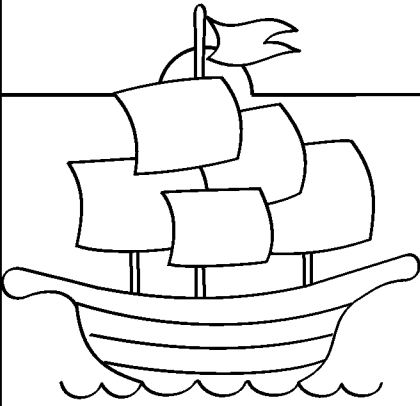
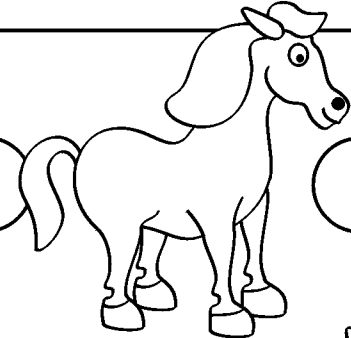
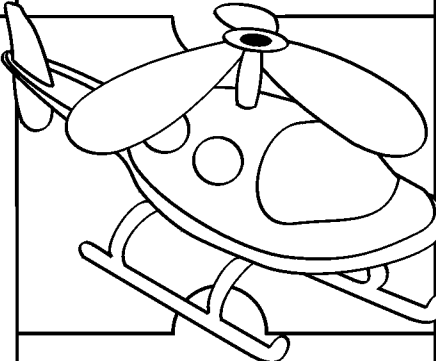
hill	hop
	
chips	hen
	
whale	hot
	

Mixed Letter Exercises

Name: _____

Which word matches the pictures?

rang ring rung sing

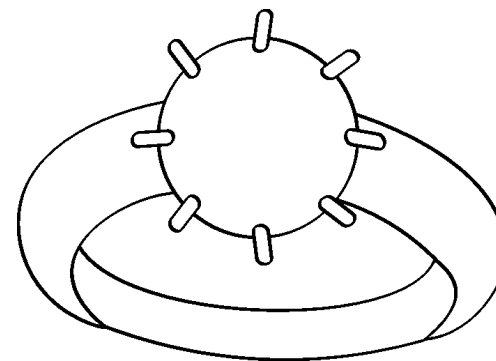

True or False?

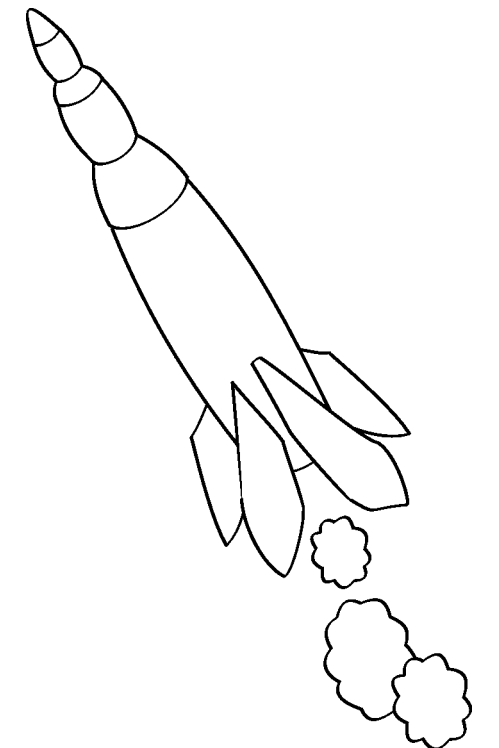

t
r
u
e

f
a
l
s
e

Here is a rocket.

Which words do not start with **r**?

are row roll rat

rip ram star read

race star rid ran

Can you find these **r** words?

~~rain~~ rag ray
red rod run

r	r	a	g	g	r
r	a	y	r	a	d
a	i	r	r	e	d
n	n	r	o	d	o
r	r	u	n	s	d

Letter *r* Jigsaw

Name: _____

Colour the words and the pictures that begin with *(r)*.

The letter 'R' is formed by several jigsaw pieces. The words and pictures are as follows:

- Top-left piece: *rat*
- Top-right piece: A picture of a rooster.
- Middle-left piece: A picture of a roll of Swiss cheese.
- Middle-right piece: *roll*
- Bottom-left piece: *are*
- Bottom-middle piece: A picture of a broom.
- Bottom-right piece: *rip*
- Far-left piece: A picture of a rhinoceros.
- Far-bottom-left piece: *here*
- Far-bottom-right piece: A picture of a star.

Mixed Letter *h* Exercises

Name: _____

Match the words to the pictures.

--	--	--	--

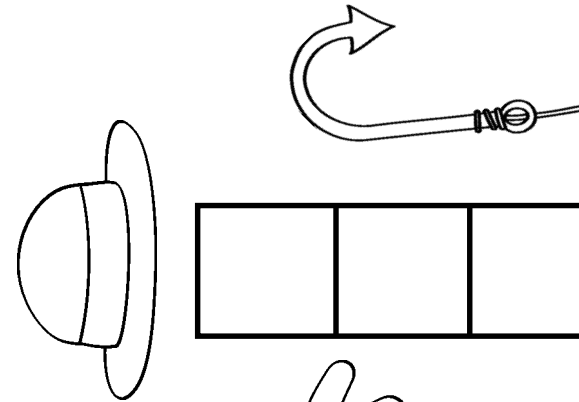

--	--	--

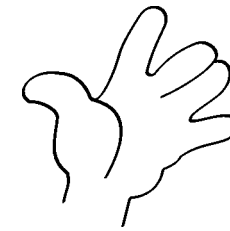

--	--	--	--

hat hook hand

Which word matches the picture?

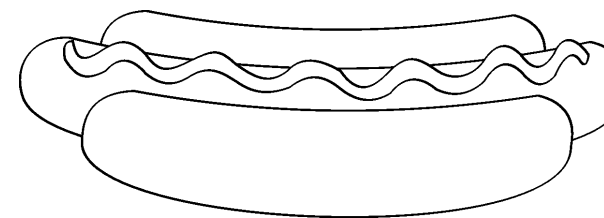

hotdog hotcat

Read and Draw

Here is a horse.

Which words do not start with *(h)*?

hip hat three hot

his hop with hill

the him here he

Letter *i* Jigsaw

Name: _____

Colour the words and the pictures that begin with *i*.

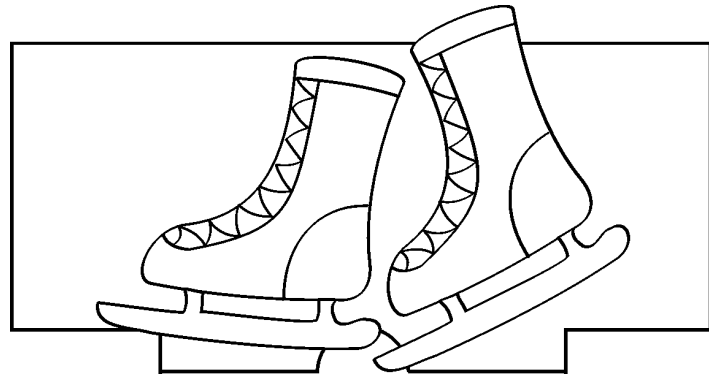

ill

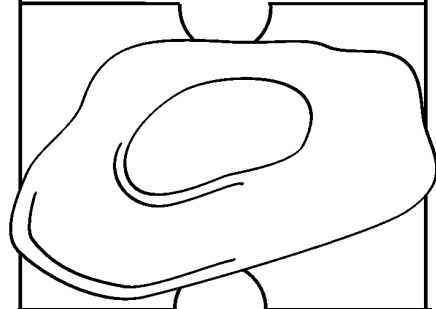

ice

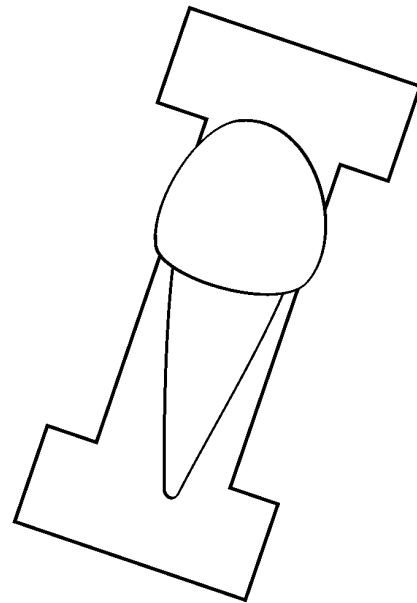
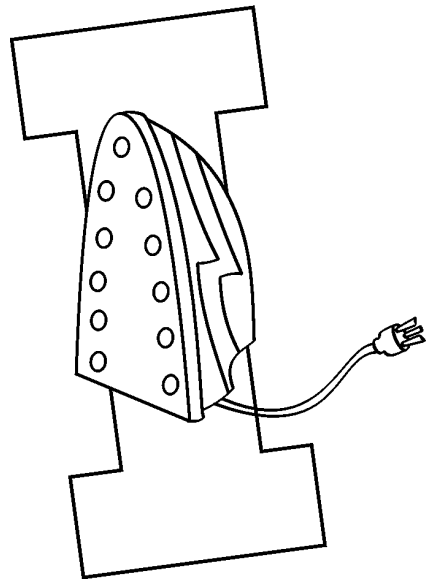
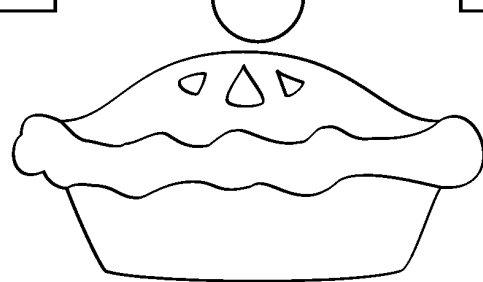

Mixed Letter *q* Exercises

Name: _____

Which word matches the picture?

seen been queen keen

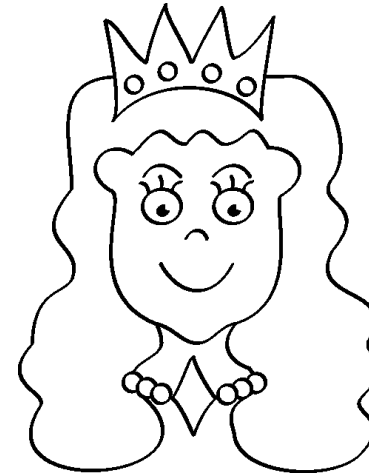

Which words do not start with *q*?

pig pipe pup quiet

quick put pit pot

pat pile quill pill

True or False?

t
r
u
e



f
a
l
s
e

This is a quilt.

Read and Draw

This is a queen.

Letter *q* Jigsaw

Name: _____

Colour the words and the pictures that begin with *q*.

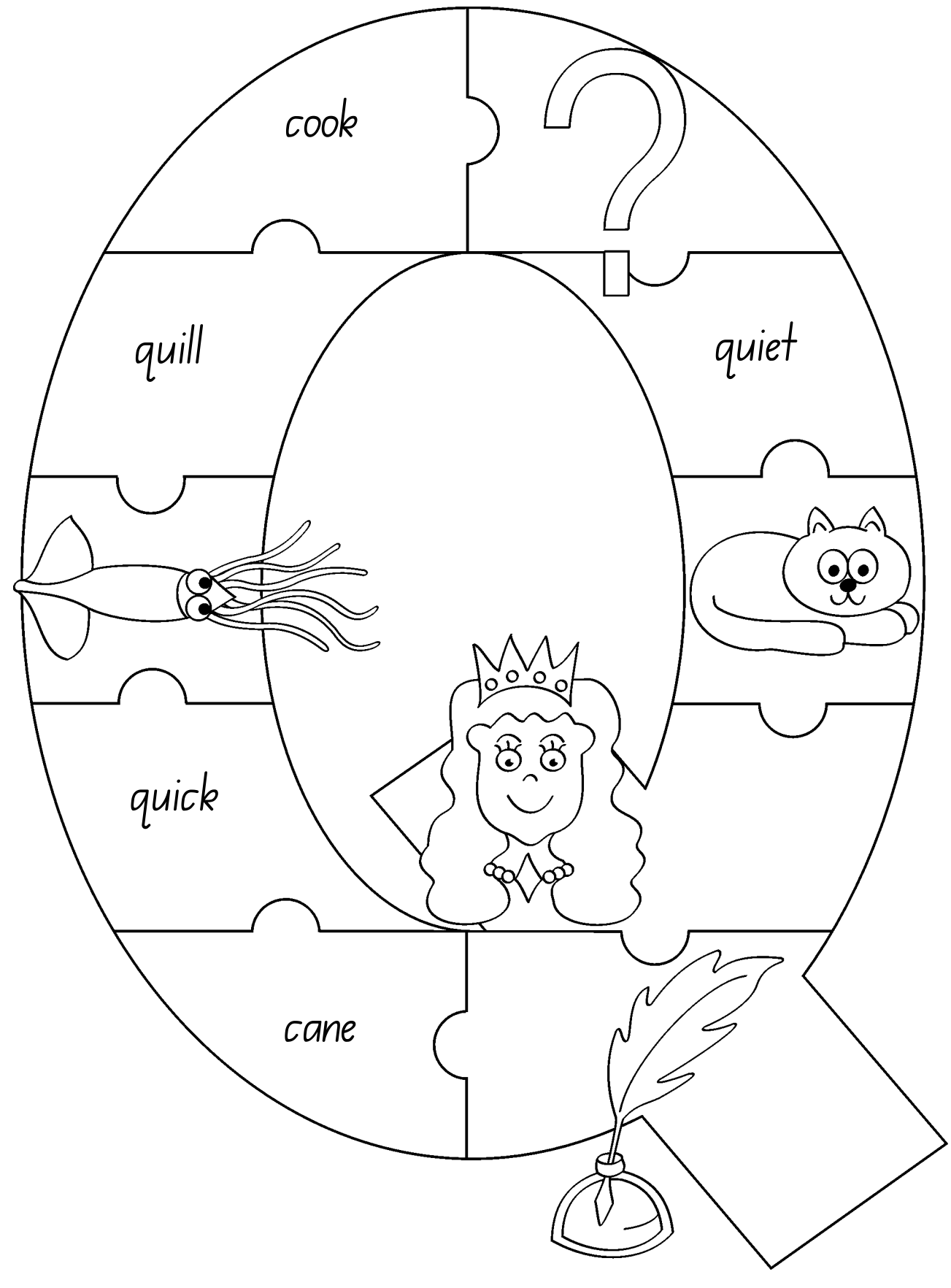

Mixed Letter *i* Exercises

Name: _____

Add *i* and draw the picture.

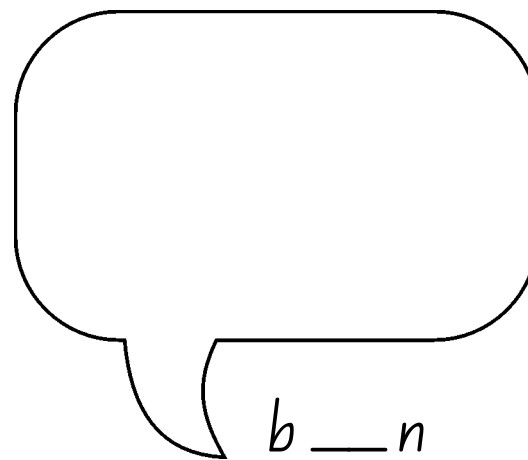
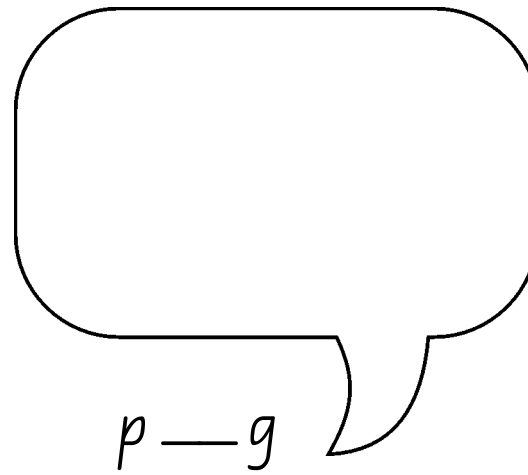
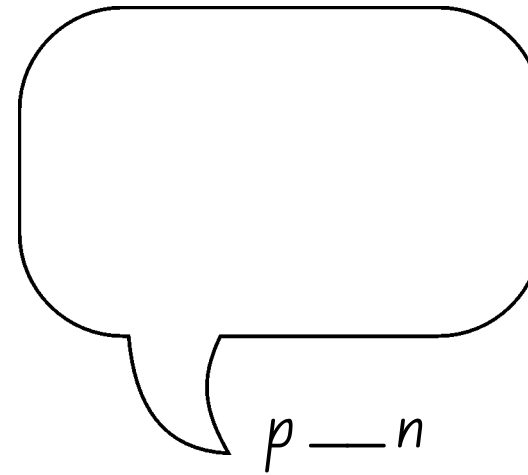

Which words do not have *i* in them?

tip hit hot fit

hip sip kid hop

pup lip pip sit

Which word matches the picture?

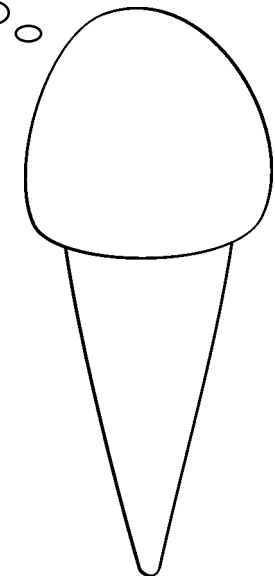
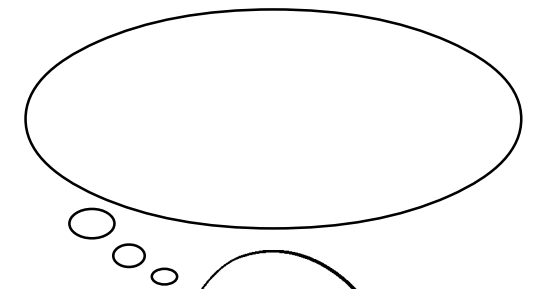

ice cream ice snow

Letter *j* Jigsaw

Name: _____

Colour the words and the pictures that begin with *j*.

game

joke

jam

angel

Mixed Letter *p* Exercises

Name: _____

Match the words to the pictures.

pen

peg

pie

pot

pen

pie

pig

peg

pot

pen

Which words do not start with *p*?

- pie ape pin pop
- pen pie pan hip
- top pit pat pup

Read and Draw

Here is a big pink pig.

Letter P Jigsaw

Name: _____

Colour the words and the pictures that begin with (p).

pen

ape

apple

pup

Mixed Letter J Exercises

Name: _____

Match the words to the pictures.

jet jug jar

Which words do not start with (j)?

jam game jet jail

job joke goat jelly

age jog jar joy

Which word matches the picture?

beans jeans

True or False?

t r u e

f a l s e

This is a jellyfish.

Letter *k* Jigsaw

Name: _____

Colour the words and the pictures that begin with **(k)**.

Mixed Letter **(o)** Exercises

Name: _____

Add **(o)** and draw the picture:

d _ g

b _ x

p _ t

Which words do not have **(o)** in them?

- only of one an
- on in open oil
- off own no orange

Which word matches the picture?

- all whale won owl



Letter O Jigsaw

Name: _____

Colour the words and the pictures that begin with **O**.

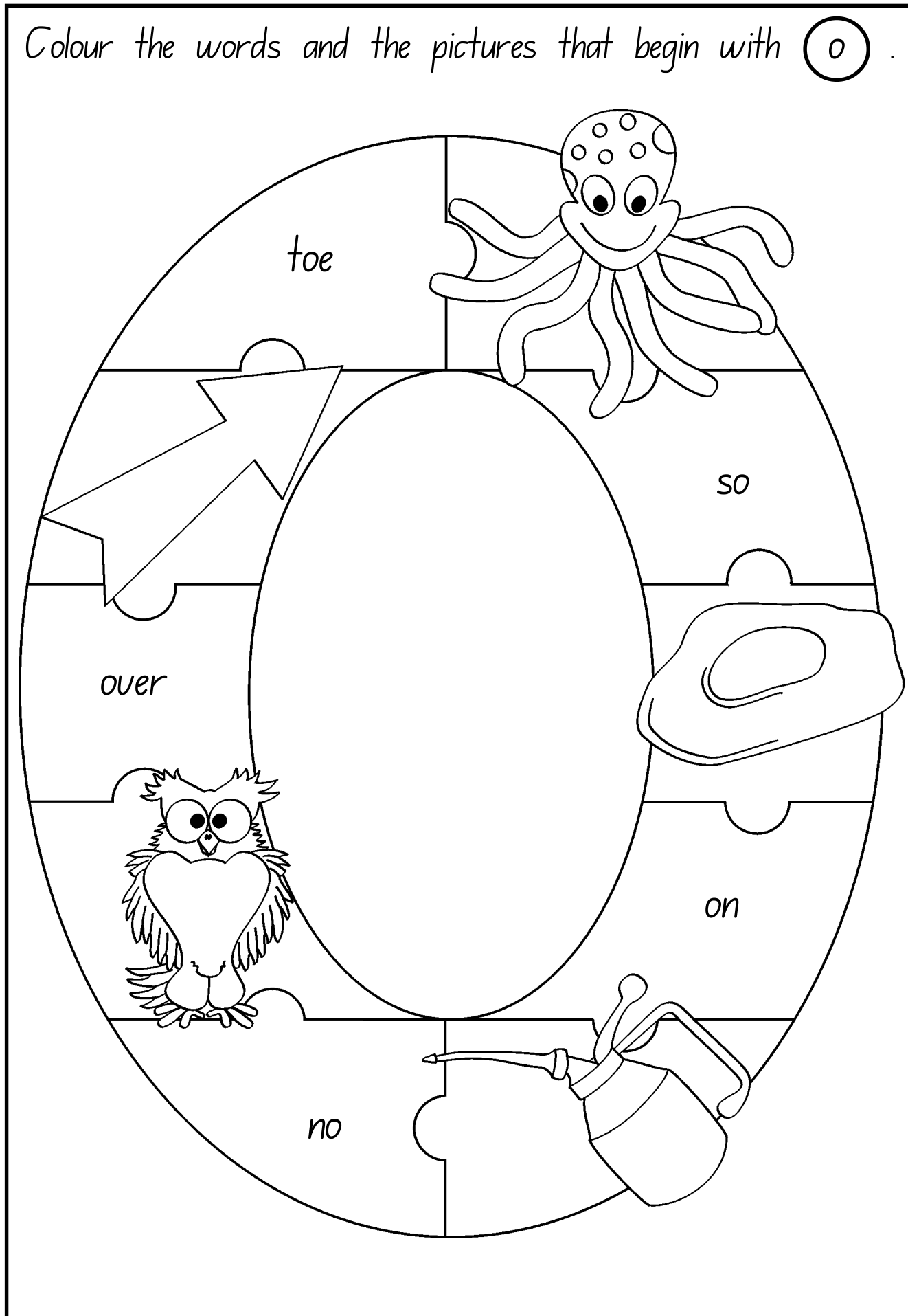

Mixed Letter **k** Exercises

Name: _____

Which words start with **k**?

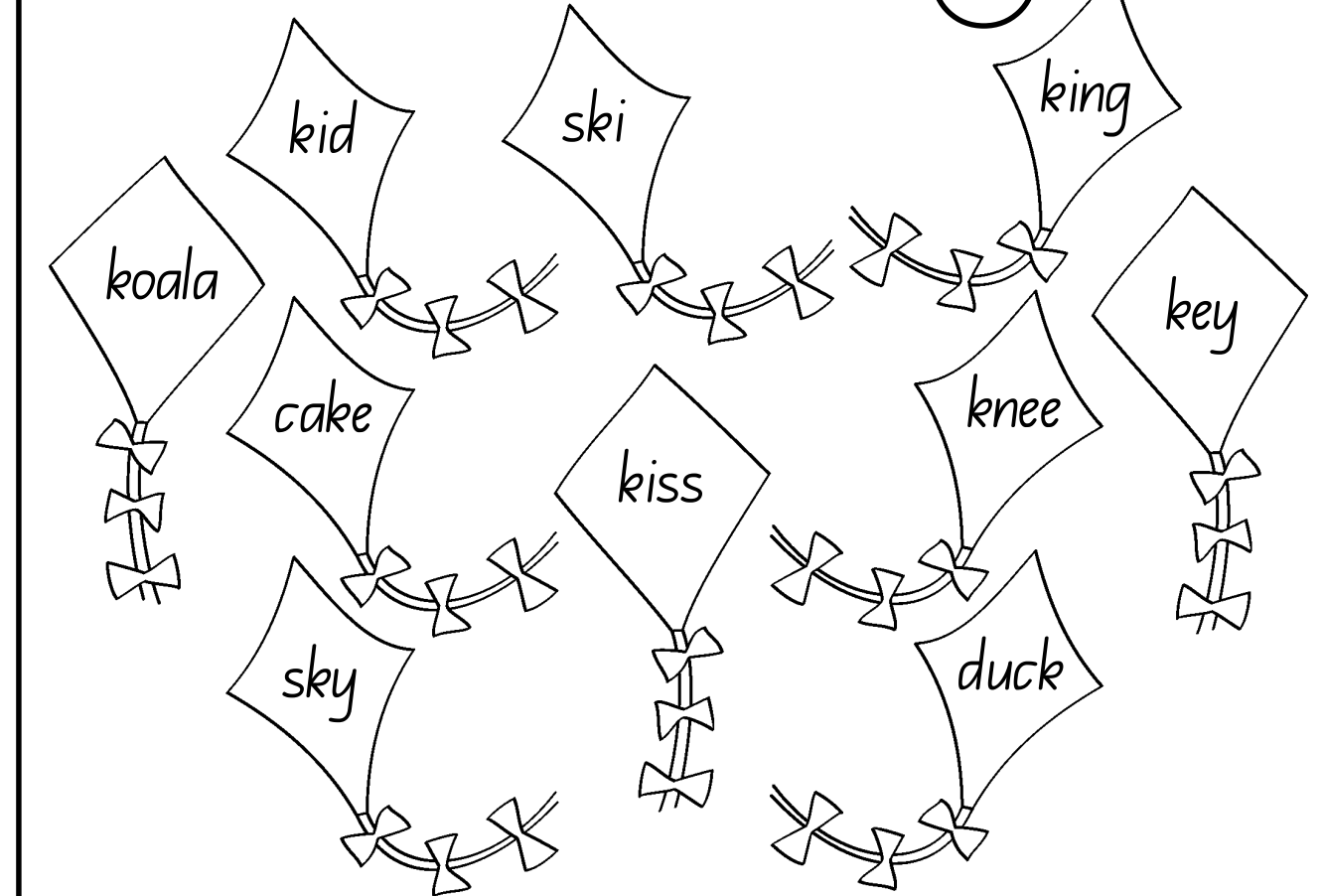

Which word matches the picture?



king

sing

Which words do not start with **k**?

keep key kid cake

bike kiss king keen

kite take kick kind

Letter / Jigsaw

Name: _____

Colour the words and the pictures that begin with (l).

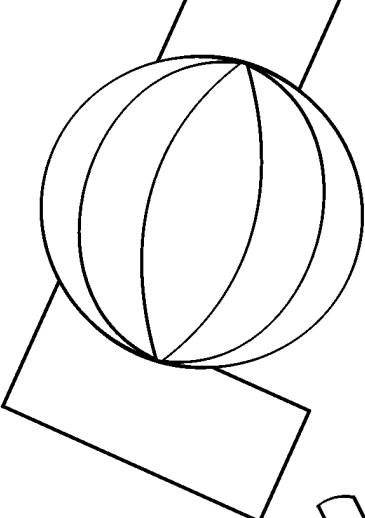
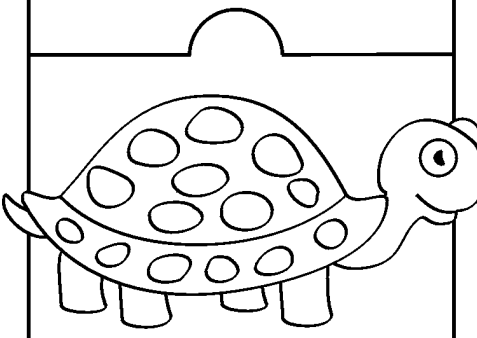
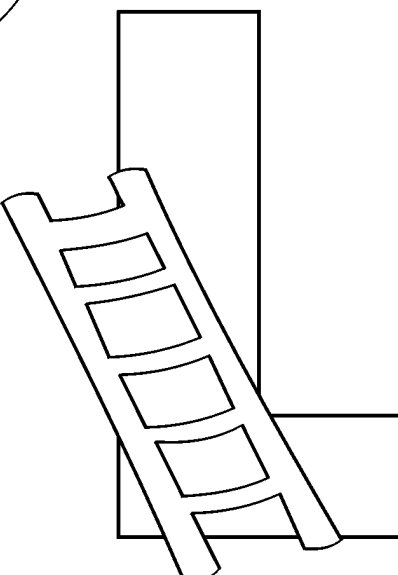
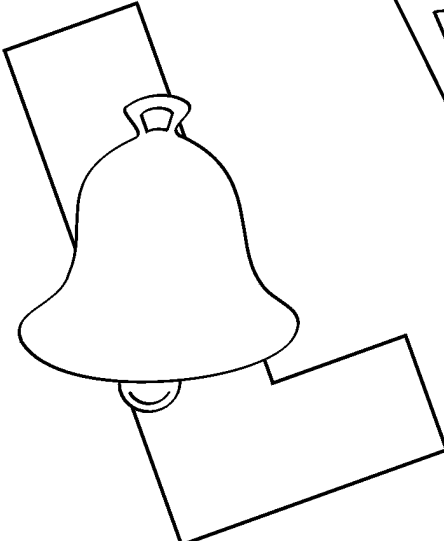
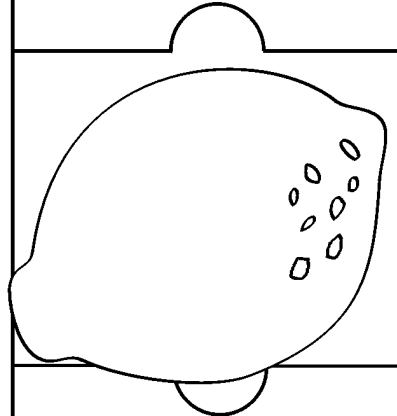
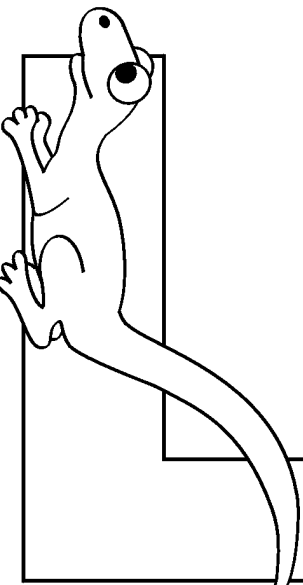
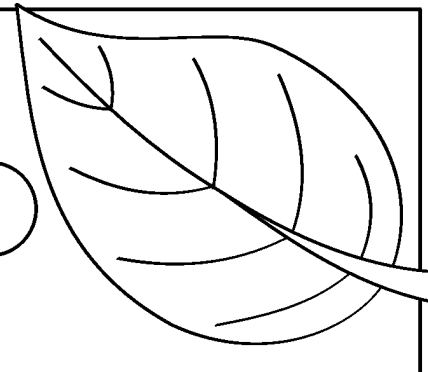
lion	
	
all	
	
fill	

Mixed Letter Exercises

Name: _____

Match the words to the pictures:

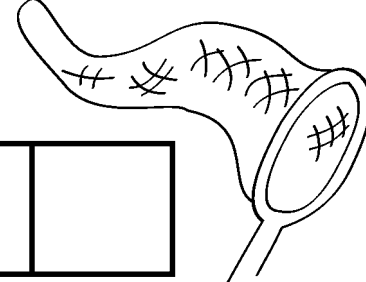

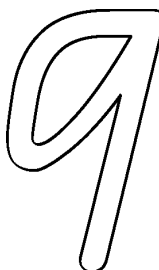

nine net nut

Which word matches the picture?

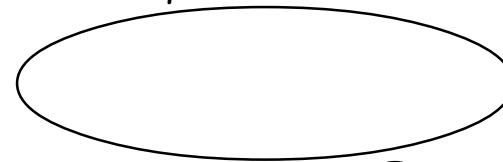

nose

toes

Read and Draw:

A clown with a red nose.

Which words do not start with (n) ?

on nut nip net

nine one new nice

not no near only

Letter N Jigsaw

Name: _____

Colour the words and the pictures that begin with (n).

nut

not

and

near

on

on

blue

red

Mixed Letter Exercises

Name: _____

Add (l) and draw the picture.

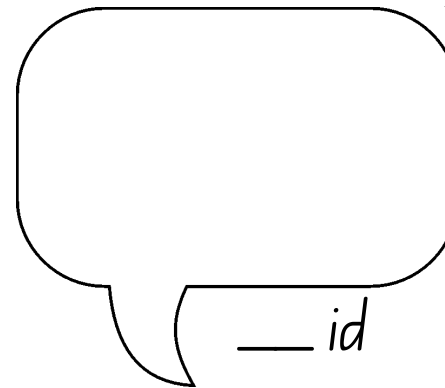
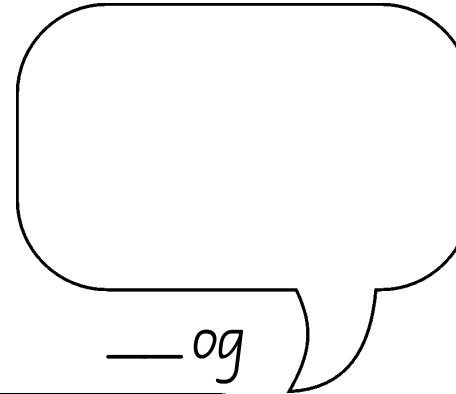

Which words do not start with (l)?

lip lid will lion

all log line late

lap last lamb also

True or False?

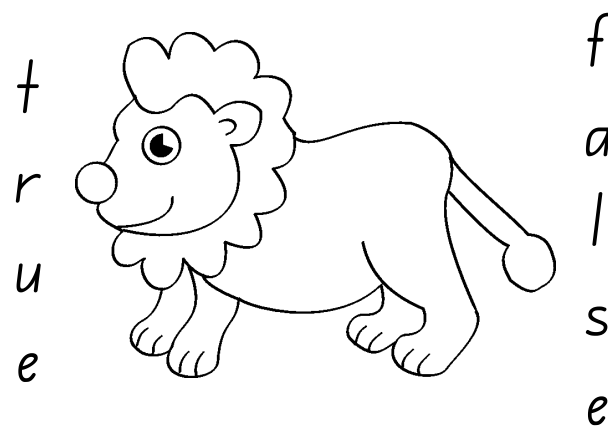

Here are two lions.

Which word matches the picture?

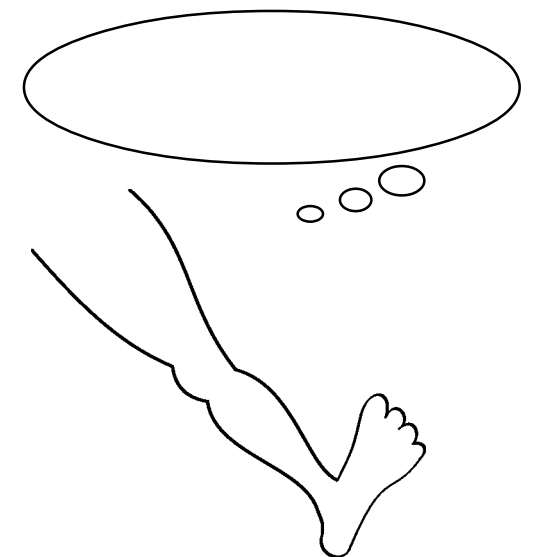

leg

log

Letter M Jigsaw

Name: _____

Colour the words and the pictures that begin with (m).

Mixed Letter M Exercises

Name: _____

Which words do not start with (m)?

man am my mix

may miss milk him

Match the words to the pictures:

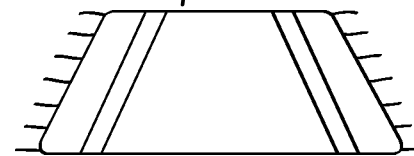

--	--	--

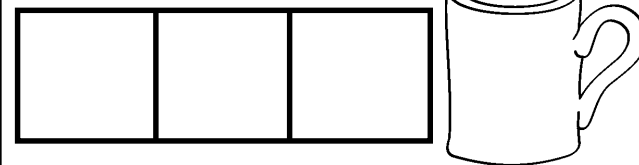

--	--	--

--	--	--



mug mat map

Add (m) and draw the picture.

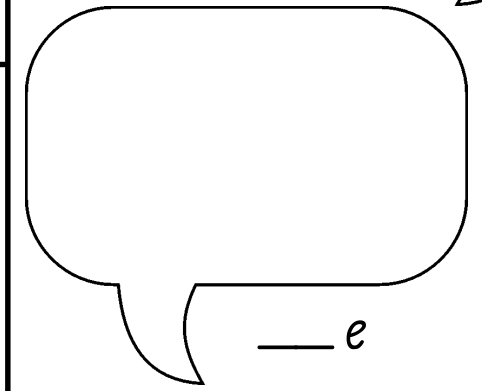
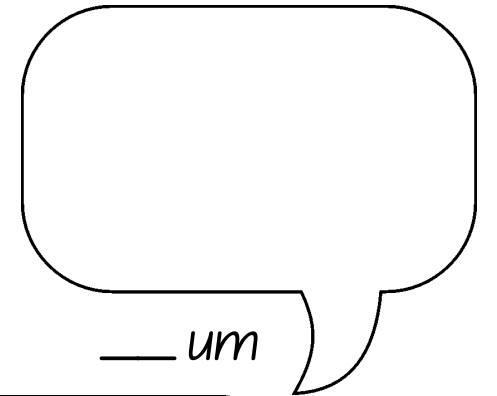

True or False?

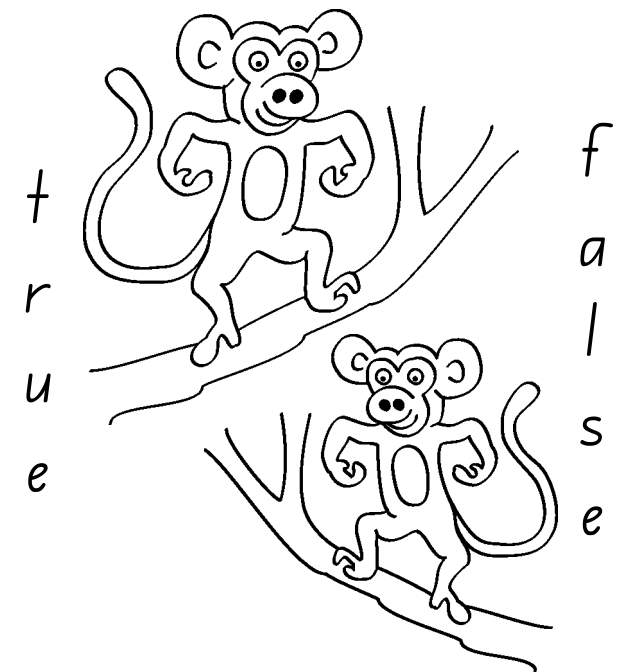

Here is one monkey.